







Features:

- Pure sine wave output
- Power ON / OFF remote control (Green Terminal)
- Remote controller CR-8 / CR-16A (optional)
- Input & Output fully isolation
- Temperature & Load controlled cooling fan
- Built in advance microprocessor to provide friendly interface
- Output frequency 50 / 60 Hz selectable by DIP switch
- Output voltage DIP switch selectable
- Adjustable power saving mode by variable resistor
- 3-color LED status indicators
- Input protection: Reverse Polarity (Fuse) / Under Voltage / Over Voltage
- Output protection: Short Circuit / Overload / Over Temperature
- E13 / UL / CE / FCC approved



MODEL		SP-700-112	SP-700-124	SP-700-148	SP-700-212	SP-700-224	SP-700-248							
Output	AC Voltage	100 / 110 / 115 / 120VAC			200 / 220 / 230 / 240VAC									
	AC Regulation	±5%			±3%									
	Rated Power	700VA												
	Surge Power (Max.3 Sec)	>805 VA~1050 VA (115%~150%)												
	Surge Power (Max.1 Sec)	>1050 VA~1400 VA (150%~200%)												
	Surge Power (Max.0.2 Sec)	>1400 VA (200%)												
	Maximum Output Power (1 Min)	>700VA~805VA (100%~115%)												
	Output Waveform	Pure Sine Wave (THD<5%@Normal Load NOTE1)			Pure Sine Wave (THD<3%@Normal Load NOTE2)									
Frequency	50 / 60 Hz ±0.5%													
Input	DC Voltage	12VDC	24VDC	48VDC	12VDC	24VDC	48VDC							
	Voltage Range	10.5 ~ 16.5VDC	21.0 ~ 33.0VDC	42.0 ~ 66.0VDC	10.5 ~ 16.5VDC	21.0 ~ 33.0VDC	42.0 ~ 66.0VDC							
	NO Load Current	≤1.5A@12VDC	≤0.8A@24VDC	≤0.5A@48VDC	≤1.5A@12VDC	≤0.8A@24VDC	≤0.5A@48VDC							
	Power Saving Mode	<0.1A@12VDC	<0.06A@24VDC	<0.05A@48VDC	<0.1A@12VDC	<0.06A@24VDC	<0.05A@48VDC							
	Efficiency (Max.)	91%	93%	93%	91%	93%	94%							
Protection	Input Under - Voltage Protection	10.5 ±0.3VDC	21.0 ±0.5VDC	42.0 ±1.0VDC	10.5 ±0.3VDC	21.0 ±0.5VDC	42.0 ±1.0VDC							
	Input Under - Voltage Recovery	12.5 ±0.3VDC	25.0 ±0.5VDC	50.0 ±1.0VDC	12.5 ±0.3VDC	25.0 ±0.5VDC	50.0 ±1.0VDC							
	Input Over - Voltage Protection	16.5 ±0.3VDC	33.0 ±0.5VDC	66.0 ±1.0VDC	16.5 ±0.3VDC	33.0 ±0.5VDC	66.0 ±1.0VDC							
	Input Over - Voltage Recovery	14.5 ±0.3VDC	29.0 ±0.5VDC	58.0 ±1.0VDC	14.5 ±0.3VDC	29.0 ±0.5VDC	58.0 ±1.0VDC							
	Output Overload	Shutdown output voltage, restart to recover												
	Output Short	Shutdown output voltage, restart to recover												
	Over Temperature	Heat sink temperature over 80°C ±5°C, shutdown output voltage, recover automatically after heat sink temperature goes down to 60°C ±5°C												
	DC Input Reverse Polarity	By fuse												
Environment	Operating Temp.	-20°C ~ +40°C ; 60°C @40% power load												
	Storage Temp.	-30°C ~ +70°C												
	Storage Temp. & Humidity	10 ~ 95% RH												
Safety & EMC	Safety Standards	Certified UL 458 NOTE3		----	Certified EN 62368-1									
	EMC Standards	Certified FCC class B			Certified EN 55032 class B; EN 55024 EN 61000-3-2, -3-3 EN 61000-4-2, 3, 4, 5, 6, 8, 11									
	E-mark	----			Certified CISPR 25 ISO 7637-2									
Control & Signal	Accessory (Optional)	Remote Control: CR-8 / CR-16A; Transfer Switch: TR-40												
	LED Indicator	Input voltage level, output load level and faulty status												
	Dry Contact Terminal	By relay												
	Remote Control Terminal	6-port green terminal												
Others	Dimension (W x H x D)	200x83x330 mm / 7.87x3.27x12.99 inch												
	Packing	2.6kg; 6pcs / 16.6kg / 3.59CUFT												
	Cooling	Temperature & load controlled cooling fan												
	Application	Home and office appliances, portable power equipment, vehicle, yacht and off-grid Solar power systems ...etc.												
	Socket Type	 North America (GFCI)		 North America (NEMA 5-15R)		 Continental European (SCHUKO)		 Australia / New Zealand		 United Kingdom		 Universal		 France Connector

Note1 - Normal Condition: Vin=12.5V / 25V / 50V Vo=100 / 110 / 115 / 120 VAC 80% Full load (PF=1.0)
 Note2 - Normal Condition: Vin=12.5V / 25V / 50V Vo=200 / 220 / 230 / 240 VAC 80% Full load (PF=1.0)
 Note3 - UL only for GFCI receptacles

Mechanical Drawings:

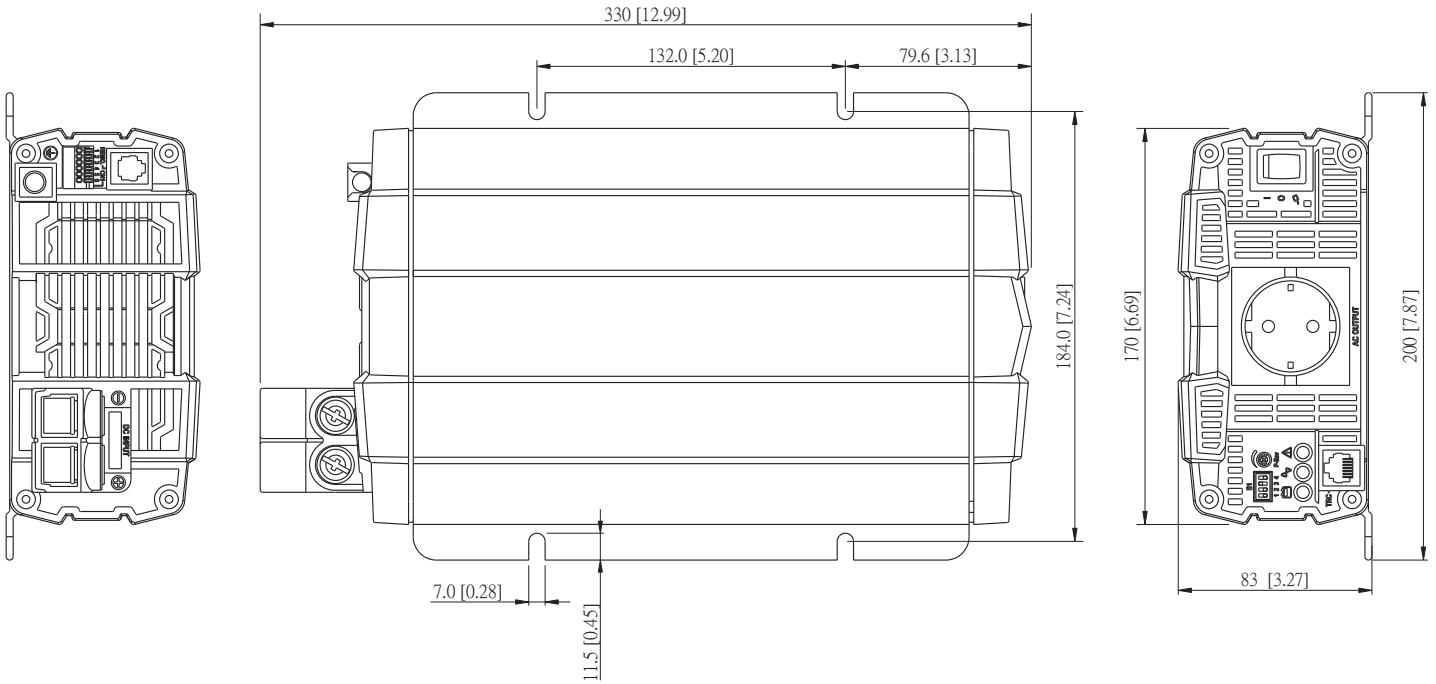

Power Voltage Curve:

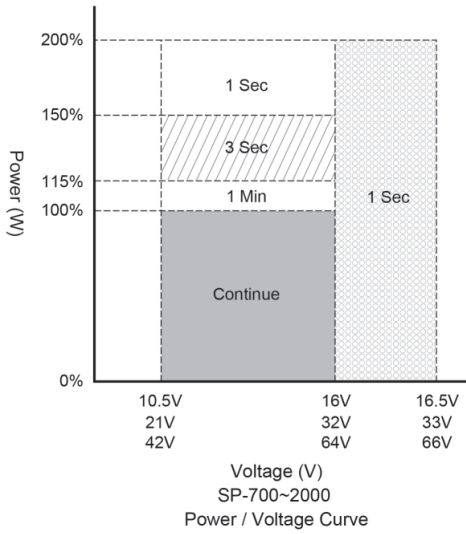

Power Temperature Curve:

